

VELALAR COLLEGE OF ENGINEERING AND TECHNOLOGY

(AUTONOMOUS)

THINDAL, ERODE

DEPARTMENT OF CIVIL ENGINEERING

15.11.2021

Circular

The Value Added course (VAC) on “Civil Engineering drawing and bar bending scheduling” is planned to be conducted by Department of Civil engineering from 18.11.2021 to 06.12.2021 for final year students. All Enrolled students are requested to attend without fail

P. Anand
15/11/21
Course Coordinator

[Signature]
HOD/Civil 15/11/21



[Signature]

PRINCIPAL

**Velalar College of Engineering and Technology
(Autonomous)**

ERODE - 638 012.

VELALAR COLLEGE OF ENGINEERING AND TECHNOLOGY, ERODE-12.

DEPARTMENT OF CIVIL ENGINEERING

Submitted to the Principal for his kind Approval

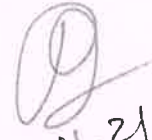
13-11-21 13.11.2021

Respected Sir,

Sub: Requisition to conduct Value Added Course for Final Year students – reg.

Our department has planned to conduct the following Value-Added Course (VAC) on Civil Engineering drawing and bar bending scheduling for the benefit of Final year students.

We kindly request you permit us to conduct this programme as per the schedule.

Value Added Course Code (if available)	: 18CEV02
Value Added Course Title	: Civil Engineering drawing and bar bending scheduling
Beneficiary	: Final Year B.E. CIVIL Students
Total number of students enrolled	: 34
Dates & Days	: 18.11.2021 & 20.11.2021, 22.11.2021 to 24.11.2021, 02.12.2021 to 04.12.2021, 6.12.2021 – 9 Days
Total number of contact periods	: 36
Outcome of the Course	: To gain knowledge on Civil Engineering drawing and bar bending scheduling, students will be able to Understand the RC detailing given in the drawing. Prepare Reinforced Concrete detailing for the Slab, Staircase, Beam and Footing.

Thanking You,

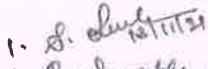
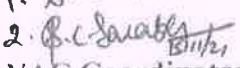
1. 
2. 
VAC Coordinator(s)





PRINCIPAL
Velalar College of Engineering and Technology
(Autonomous)
ERODE - 638 012.

HoD/CIVIL

(Dr.E.Ravi)

18CEV02	Civil Engineering drawing and bar bending scheduling	L T P C 0 0 2 1
Prerequisite:		
18CET51 - DESIGN OF REINFORCED CONCRETE ELEMENTS		
Preamble:		
Bar bending schedule is an important structural working document that rightly gives the disposition, bending shape, and total length of all the reinforcements that have been provided in the structural drawing, including the quantity.		
Course Outcomes: Upon completion of the course, students will be able to:		
1.	Understand the RC detailing given in the drawing.	
2.	Prepare Reinforced Concrete detailing for the Slab, Staircase, Beam and Footing.	
Module 1 – Basics of bar bending schedule		10
<ul style="list-style-type: none"> ● Basics of bar bending schedule ● Reading and understanding relevant specification given in the drawing ● Types of steel (TOR, MILD steel) ● Difference between clear cover and effective cover ● Importance of spacing and diameter of reinforcement ● Identification & importance of main & secondary bar ● Identification of different types of stirrups and cranks/ shear bars 		
Module 2 – RCC detailing using software		20
Generation of detailed drawings for given specification and preparation of bar bending schedule using AutoCAD <ul style="list-style-type: none"> ● Continuous one-way slab (with three equal spans) ● Simply supported two-way slab ● Doubly reinforced continuous beam with two equal spans ● Dog-legged staircase ● RCC column with square isolated footing 		
TOTAL: 30 PERIODS		
REFERENCES:		
1. IS456:2000, Code of practice for Plain and Reinforced Concrete, Bureau of Indian Standards, New Delhi, 2000.		
2. SP 34-1987 Handbook on reinforcement and detailing, Bureau of Indian Standards, New Delhi, 2000.		
e-Resources:		
1.		

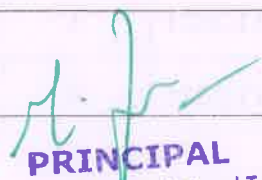



PRINCIPAL
 Velalar College of Engineering and Technology
 (Autonomous)
 ERODE - 638 012.

Session Details

S.No	Date	Periods	Topic	Remarks
1	18.11.2021	1	Basics of bar bending schedule	
2	18.11.2021	2	Reading and understanding relevant specification given in the drawing	
3	18.11.2021	3	Introduction to IS456 Code book	
4	18.11.2021	4	Introduction to SP34 Code book	
5	20.11.2021	1	Types of steel , Difference between clear cover and effective cover	
6	20.11.2021	2	Importance of spacing and diameter of reinforcement	
7	20.11.2021	3	Identification & importance of main & secondary bar	
8	20.11.2021	4	Identification of different types of stirrups and cranks/ shear bars	
9	22.11.2021	1	Doubly reinforced Simply supported beam	
10	22.11.2021	2	Doubly reinforced continuous beam with two equal spans	
11	22.11.2021	3	Practical Session	
12	22.11.2021	4	Practical Session	
13	23.11.2021	1	Simply supported one-way slab	
14	23.11.2021	2	Continuous one-way slab (with three equal spans)	
15	23.11.2021	3	Practical Session	
16	23.11.2021	4	Practical Session	
17	24.11.2021	1	Simply supported Two-way slab	
18	24.11.2021	2	Dog-legged staircase	
19	24.11.2021	3	Practical Session	
20	24.11.2021	4	Practical Session	

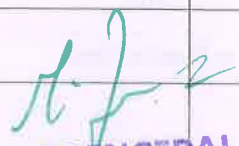



PRINCIPAL
 Velalar College of Engineering and Technology
 (Autonomous)
 ERODE - 638 012.

21	02.12.2021	1	RCC column	
22	02.12.2021	2	Practical Session	
23	02.12.2021	3	Practical Session	
24	02.12.2021	4	Practical Session	
25	03.12.2021	1	Cantilever Structures	
26	03.12.2021	2	Practical Session	
27	03.12.2021	3	Practical Session	
28	03.12.2021	4	Practical Session	
29	04.12.2021	1	Square Isolated footing	
30	04.12.2021	2	Practical Session	
31	04.12.2021	3	Practical Session	
32	04.12.2021	4	Practical Session	
33	06.12.2021	1	Opportunities in Rebar Detailing	
34	06.12.2021	2	Test	
35	06.12.2021	3	Test	
36	06.12.2021	4	Feedback Session	

HOD/CIVIL



PRINCIPAL
Velalar College of Engineering and Technology
(Autonomous)
ERODE - 638 012.

VELALAR COLLEGE OF ENGINEERING AND TECHNOLOGY
DEPARTMENT OF CIVIL ENGINEERING
VALUE ADDED COURSE
NAME LIST

CLASS:18CE7

BATCH:2018-22

S.No	Reg. No.	Name of the Student
1	18CEA001	VIJAYARANGAN V
2	18CEL001	EDWIN.J
3	18CEL002	GOKULAKRISHNAN.C
4	18CEL003	MOHANSHYAM.T
5	18CEL004	SANTHOSH T K
6	18CEL005	R.SANTHOSH KUMAR
7	18CEL006	SATHEESH KUMAR.S
8	18CEL007	S.YOGESH
9	18CER001	DEVANATHAN A.P
10	18CER002	DHARANI V N
11	18CER003	A.DHIVYA
12	18CER004	R.S.DIVAGAR
13	18CER005	M.HARITHA
14	18CER006	HRITHIK.K
15	18CER007	R.JAYAMAIIIMA
16	18CER008	JEEVANANDHAM.G
17	18CER009	JEEVITHA R
18	18CER010	KABILAN.PL
19	18CER011	MATHESH.R
20	18CER012	P.MAYURII
21	18CER013	MOHANAPRASHANTH B
22	18CER015	NITHEESKUMAR.R
23	18CER016	RAGESH R
24	18CER017	S.RANJITHKUMAR
25	18CER018	SHIVASHANGAR. M
26	18CER019	SIJIN.S
27	18CER020	D. SIVARANJANI
28	18CER021	C.SOWMITHA
29	18CER023	V.SRIPATHI
30	18CER024	SUBHIKSHA. G. R
31	18CER025	P.E.SURESH
32	18CER026	S.SUVETHA
33	18CER027	A.SWATHI PRIYA
34	18CER028	V.VIVEKA

B.C. Suresh
VAC Coordinators(s)

Ja
HOD/Civil



N.J.
PRINCIPAL
Velalar College of Engineering and Technology
(Autonomous)
ERODE - 638 012.

VELALAR COLLEGE OF ENGINEERING AND TECHNOLOGY
DEPARTMENT OF CIVIL ENGINEERING
VALUE ADDED COURSE ATTENDANCE

CLASS:18CE7

BATCH:2018-22

S.No	Reg. No.	Name of the Student	Session 1	Session 2	Session 3	Session 4	Session 5	Session 6	Session 7	Session 8	Session 9	Session 10	Session 11	Session 12	Session 13	Session 14	Session 15
1	18CEA001	VIJAYARANGAN V	V.V	V.V	V.V	V.V	V.V	V.V	V.V	V.V	V.V	V.V	V.V	V.V	V.V	V.V	V.V
2	18CEL001	EDWIN.J	J.Edwin	J.Edwin	J.Edwin	J.Edwin	J.Edwin	J.Edwin	J.Edwin	J.Edwin	J.Edwin	J.Edwin	J.Edwin	J.Edwin	J.Edwin	J.Edwin	J.Edwin
3	18CEL002	GOKULAKRISHNAN.C	C.Gokul	C.Gokul	C.Gokul	C.Gokul	C.Gokul	C.Gokul	C.Gokul	C.Gokul	C.Gokul	C.Gokul	C.Gokul	C.Gokul	C.Gokul	C.Gokul	C.Gokul
4	18CEL003	MOHANSHYAM.T	AB	AB	AB	AB	AB	AB	AB	AB	AB	AB	AB	AB	AB	AB	AB
5	18CEL004	SANTHOSH T K	T.K	T.K	T.K	T.K	T.K	T.K	T.K	T.K	T.K	T.K	T.K	T.K	T.K	T.K	T.K
6	18CEL005	R.SANTHOSH KUMAR	R.S	R.S	R.S	R.S	R.S	R.S	R.S	R.S	R.S	R.S	R.S	R.S	R.S	R.S	R.S
7	18CEL006	SATHEESH KUMAR.S	S.Satheesh	S.Satheesh	S.Satheesh	S.Satheesh	S.Satheesh	S.Satheesh	S.Satheesh	S.Satheesh	S.Satheesh	S.Satheesh	S.Satheesh	S.Satheesh	S.Satheesh	S.Satheesh	S.Satheesh
8	18CEL007	S.YOGESH	S.Yogesh	S.Yogesh	S.Yogesh	S.Yogesh	S.Yogesh	S.Yogesh	S.Yogesh	S.Yogesh	S.Yogesh	S.Yogesh	S.Yogesh	S.Yogesh	S.Yogesh	S.Yogesh	S.Yogesh
9	18CER001	DEVANATHAN A.P	A.P	A.P	A.P	A.P	A.P	A.P	A.P	A.P	A.P	A.P	A.P	A.P	A.P	A.P	A.P
10	18CER002	DHARANI V N	V.N	V.N	V.N	V.N	V.N	V.N	V.N	V.N	V.N	V.N	V.N	V.N	V.N	V.N	V.N
11	18CER003	A.DHIVYA	A.Dhivya	A.Dhivya	A.Dhivya	A.Dhivya	A.Dhivya	A.Dhivya	A.Dhivya	A.Dhivya	A.Dhivya	A.Dhivya	A.Dhivya	A.Dhivya	A.Dhivya	A.Dhivya	A.Dhivya
12	18CER004	R.S.DIVAGAR	R.S	R.S	R.S	R.S	R.S	R.S	R.S	R.S	R.S	R.S	R.S	R.S	R.S	R.S	R.S
13	18CER005	M.HARITHA	M.Haritha	M.Haritha	M.Haritha	M.Haritha	M.Haritha	M.Haritha	M.Haritha	M.Haritha	M.Haritha	M.Haritha	M.Haritha	M.Haritha	M.Haritha	M.Haritha	M.Haritha
14	18CER006	HRITHIK.K	K.Hrithik	K.Hrithik	K.Hrithik	K.Hrithik	K.Hrithik	K.Hrithik	K.Hrithik	K.Hrithik	K.Hrithik	K.Hrithik	K.Hrithik	K.Hrithik	K.Hrithik	K.Hrithik	K.Hrithik
15	18CER007	R.JAYAMAHIMA	R.Jayama	R.Jayama	R.Jayama	R.Jayama	R.Jayama	R.Jayama	R.Jayama	R.Jayama	R.Jayama	R.Jayama	R.Jayama	R.Jayama	R.Jayama	R.Jayama	R.Jayama
16	18CER008	JEEVANANDHAM.G	G.Jeevan	G.Jeevan	G.Jeevan	G.Jeevan	G.Jeevan	G.Jeevan	G.Jeevan	G.Jeevan	G.Jeevan	G.Jeevan	G.Jeevan	G.Jeevan	G.Jeevan	G.Jeevan	G.Jeevan
17	18CER009	JEEVITHA R	R.Jeevitha	R.Jeevitha	R.Jeevitha	R.Jeevitha	R.Jeevitha	R.Jeevitha	R.Jeevitha	R.Jeevitha	R.Jeevitha	R.Jeevitha	R.Jeevitha	R.Jeevitha	R.Jeevitha	R.Jeevitha	R.Jeevitha
18	18CER010	KABILAN.PL	P.L	P.L	P.L	P.L	P.L	P.L	P.L	P.L	P.L	P.L	P.L	P.L	P.L	P.L	P.L
19	18CER011	MATHESH.R	R.Mathesh	R.Mathesh	R.Mathesh	R.Mathesh	R.Mathesh	R.Mathesh	R.Mathesh	R.Mathesh	R.Mathesh	R.Mathesh	R.Mathesh	R.Mathesh	R.Mathesh	R.Mathesh	R.Mathesh
20	18CER012	P.MAYURII	P.Mayuri	P.Mayuri	P.Mayuri	P.Mayuri	P.Mayuri	P.Mayuri	P.Mayuri	P.Mayuri	P.Mayuri	P.Mayuri	P.Mayuri	P.Mayuri	P.Mayuri	P.Mayuri	P.Mayuri
21	18CER013	MOHANAPRASHANTH B	B.Mohan	B.Mohan	B.Mohan	B.Mohan	B.Mohan	B.Mohan	B.Mohan	B.Mohan	B.Mohan	B.Mohan	B.Mohan	B.Mohan	B.Mohan	B.Mohan	B.Mohan
22	18CER015	NITHEESKUMAR.R	R.Nitheesh	R.Nitheesh	R.Nitheesh	R.Nitheesh	R.Nitheesh	R.Nitheesh	R.Nitheesh	R.Nitheesh	R.Nitheesh	R.Nitheesh	R.Nitheesh	R.Nitheesh	R.Nitheesh	R.Nitheesh	R.Nitheesh
23	18CER016	RAGESH R	R.Ragesh	R.Ragesh	R.Ragesh	R.Ragesh	R.Ragesh	R.Ragesh	R.Ragesh	R.Ragesh	R.Ragesh	R.Ragesh	R.Ragesh	R.Ragesh	R.Ragesh	R.Ragesh	R.Ragesh
24	18CER017	S.RANJITHKUMAR	S.Ranjith	S.Ranjith	S.Ranjith	S.Ranjith	S.Ranjith	S.Ranjith	S.Ranjith	S.Ranjith	S.Ranjith	S.Ranjith	S.Ranjith	S.Ranjith	S.Ranjith	S.Ranjith	S.Ranjith
25	18CER018	SHIVASHANGAR.M	M.Shivashangar	M.Shivashangar	M.Shivashangar	M.Shivashangar	M.Shivashangar	M.Shivashangar	M.Shivashangar	M.Shivashangar	M.Shivashangar	M.Shivashangar	M.Shivashangar	M.Shivashangar	M.Shivashangar	M.Shivashangar	M.Shivashangar
26	18CER019	SIJIN.S	S.Sijin	S.Sijin	S.Sijin	S.Sijin	S.Sijin	S.Sijin	S.Sijin	S.Sijin	S.Sijin	S.Sijin	S.Sijin	S.Sijin	S.Sijin	S.Sijin	S.Sijin
27	18CER020	D. SIVARANJANI	D.Sivaranjani	D.Sivaranjani	D.Sivaranjani	D.Sivaranjani	D.Sivaranjani	D.Sivaranjani	D.Sivaranjani	D.Sivaranjani	D.Sivaranjani	D.Sivaranjani	D.Sivaranjani	D.Sivaranjani	D.Sivaranjani	D.Sivaranjani	D.Sivaranjani
28	18CER021	C.SOWMITHA	C.Sowmitha	C.Sowmitha	C.Sowmitha	C.Sowmitha	C.Sowmitha	C.Sowmitha	C.Sowmitha	C.Sowmitha	C.Sowmitha	C.Sowmitha	C.Sowmitha	C.Sowmitha	C.Sowmitha	C.Sowmitha	C.Sowmitha
29	18CER023	V.SRIPATHI	V.Sripathi	V.Sripathi	V.Sripathi	V.Sripathi	V.Sripathi	V.Sripathi	V.Sripathi	V.Sripathi	V.Sripathi	V.Sripathi	V.Sripathi	V.Sripathi	V.Sripathi	V.Sripathi	V.Sripathi
30	18CER024	SUBHIKSHA. G. R	G.R.Subhiksha	G.R.Subhiksha	G.R.Subhiksha	G.R.Subhiksha	G.R.Subhiksha	G.R.Subhiksha	G.R.Subhiksha	G.R.Subhiksha	G.R.Subhiksha	G.R.Subhiksha	G.R.Subhiksha	G.R.Subhiksha	G.R.Subhiksha	G.R.Subhiksha	G.R.Subhiksha
31	18CER025	P.E.SURESH	P.E.Suresh	P.E.Suresh	P.E.Suresh	P.E.Suresh	P.E.Suresh	P.E.Suresh	P.E.Suresh	P.E.Suresh	P.E.Suresh	P.E.Suresh	P.E.Suresh	P.E.Suresh	P.E.Suresh	P.E.Suresh	P.E.Suresh
32	18CER026	S.SUVETHA	S.Suvetha	S.Suvetha	S.Suvetha	S.Suvetha	S.Suvetha	S.Suvetha	S.Suvetha	S.Suvetha	S.Suvetha	S.Suvetha	S.Suvetha	S.Suvetha	S.Suvetha	S.Suvetha	S.Suvetha
33	18CER027	A.SWATHI PRIYA	A.Swathi	A.Swathi	A.Swathi	A.Swathi	A.Swathi	A.Swathi	A.Swathi	A.Swathi	A.Swathi	A.Swathi	A.Swathi	A.Swathi	A.Swathi	A.Swathi	A.Swathi
34	18CER028	V.VIVEKA	V.Viveka	V.Viveka	V.Viveka	V.Viveka	V.Viveka	V.Viveka	V.Viveka	V.Viveka	V.Viveka	V.Viveka	V.Viveka	V.Viveka	V.Viveka	V.Viveka	V.Viveka



PRINCIPAL
 Velalar College of Engineering and Technology
 (Autonomous)
 ERODE - 638 012.

VELALAR COLLEGE OF ENGINEERING AND TECHNOLOGY
DEPARTMENT OF CIVIL ENGINEERING
VALUE ADDED COURSE ATTENDANCE

CLASS:18CE7

BATCH:2018-22

S.No	Reg. No.	Name of the Student	Session 16	Session 17	Session 18	Session 19	Session 20	Session 21	Session 22	Session 23	Session 24	Session 25	Session 26	Session 27	Session 28	Session 29	Session 30
1	18CEA001	VIJAYARANGAN V	J	J	J	J	J	J	J	J	J	J	J	J	J	J	J
2	18CEL001	EDWIN.J	J	J	J	J	J	J	J	J	J	J	J	J	J	J	J
3	18CEL002	GOKULAKRISHNAN.C	C	C	C	C	C	C	C	C	C	C	C	C	C	C	C
4	18CEL003	MOHANSHYAM.T	T	T	T	T	T	T	T	T	T	T	T	T	T	T	T
5	18CEL004	SANTHOSH T K	T	T	T	T	T	T	T	T	T	T	T	T	T	T	T
6	18CEL005	R.SANTHOSH KUMAR	R	R	R	R	R	R	R	R	R	R	R	R	R	R	R
7	18CEL006	SATHEESH KUMAR.S	S	S	S	S	S	S	S	S	S	S	S	S	S	S	S
8	18CEL007	S.YOGESH	Y	Y	Y	Y	Y	Y	Y	Y	Y	Y	Y	Y	Y	Y	Y
9	18CER001	DEVANATHAN A.P	D	D	D	D	D	D	D	D	D	D	D	D	D	D	D
10	18CER002	DHARANI V N	D	D	D	D	D	D	D	D	D	D	D	D	D	D	D
11	18CER003	A.DHIVYA	A	A	A	A	A	A	A	A	A	A	A	A	A	A	A
12	18CER004	R.S.DIVAGAR	R	R	R	R	R	R	R	R	R	R	R	R	R	R	R
13	18CER005	M.HARITHA	M	M	M	M	M	M	M	M	M	M	M	M	M	M	M
14	18CER006	HRITHIK.K	H	H	H	H	H	H	H	H	H	H	H	H	H	H	H
15	18CER007	R.JAYAMAHIMA	R	R	R	R	R	R	R	R	R	R	R	R	R	R	R
16	18CER008	JEEVANANDHAM.G	J	J	J	J	J	J	J	J	J	J	J	J	J	J	J
17	18CER009	JEEVITHA R	J	J	J	J	J	J	J	J	J	J	J	J	J	J	J
18	18CER010	KABILAN.PL	K	K	K	K	K	K	K	K	K	K	K	K	K	K	K
19	18CER011	MATHESH.R	M	M	M	M	M	M	M	M	M	M	M	M	M	M	M
20	18CER012	P.MAYURII	P	P	P	P	P	P	P	P	P	P	P	P	P	P	P
21	18CER013	MOHANAPRASHANTH B	M	M	M	M	M	M	M	M	M	M	M	M	M	M	M
22	18CER015	NITHEESKUMAR.R	N	N	N	N	N	N	N	N	N	N	N	N	N	N	N
23	18CER016	RAGESH R	R	R	R	R	R	R	R	R	R	R	R	R	R	R	R
24	18CER017	S.RANJITHKUMAR	S	S	S	S	S	S	S	S	S	S	S	S	S	S	S
25	18CER018	SHIVASHANGAR. M	S	S	S	S	S	S	S	S	S	S	S	S	S	S	S
26	18CER019	SIJIN.S	S	S	S	S	S	S	S	S	S	S	S	S	S	S	S
27	18CER020	D. SIVARANJANI	D	D	D	D	D	D	D	D	D	D	D	D	D	D	D
28	18CER021	C.SOWMITHA	C	C	C	C	C	C	C	C	C	C	C	C	C	C	C
29	18CER023	V.SRIPATHI	V	V	V	V	V	V	V	V	V	V	V	V	V	V	V
30	18CER024	SUBHIKSHA. G. R	S	S	S	S	S	S	S	S	S	S	S	S	S	S	S
31	18CER025	P.E.SURESH	P	P	P	P	P	P	P	P	P	P	P	P	P	P	P
32	18CER026	S.SUVETHA	S	S	S	S	S	S	S	S	S	S	S	S	S	S	S
33	18CER027	A.SWATHI PRIYA	A	A	A	A	A	A	A	A	A	A	A	A	A	A	A
34	18CER028	V.VIVEKA	V	V	V	V	V	V	V	V	V	V	V	V	V	V	V



PRINCIPAL

ABOUT THE INSTITUTION

Velalar College of Engineering and Technology, Thindal, Erode is a self-financing co-educational institution established in the year 2001 with all the necessary infrastructural facilities provided through the vision of Velalar Educational Trust that ably governs the institution. The college is approved by the AICTE, New Delhi, affiliated to Anna University, Chennai and is accredited by NAAC with 'A' Grade. The institution has completed 17 years of dedicated and excellent service in the field of technical education. This institution offers 7 UG & 5 PG programmes. The following programmes were accredited by NBA, New Delhi, Viz. BME, CSE, ECE, EEE and IT. The institution has been conferred with autonomous status by UGC, New Delhi from the academic year 2016-2017 onwards. There are six research centres in the institution viz. Chemistry, Management studies, EEE, ECE, CSE and Physics.

ABOUT THE DEPARTMENT

The Department of Civil Engineering was established in the academic year 2012-2013. It offers UG degree in Civil Engineering. Since inception, the department provides an encouraging environment and imparts the latest advancements in knowledge and skills through innovative methods of teaching. The Department has qualified faculty members with well equipped laboratories.

ABOUT THE SEMINAR

- To enhance their knowledge in bar bending schedule which is used in Civil Engineering buildings.
- To provide an in-depth knowledge in use of Detailing.

LOCATION

The College is situated at Thindal, 8km from Erode and 11km from Perundurai on Erode-Perundurai road.

ADDRESS FOR COMMUNICATION

Mr.S.Suresh

Assistant Professor,
Department of Civil Engineering,
Velalar College of Engineering and Technology,
Thindal, Erode-638 012.

Mobile - 9751677970

Mr.S.C.Sarath Kumar

Assistant Professor,
Department of Civil Engineering,
Velalar College of Engineering and Technology,
Thindal, Erode-638 012.

Mobile - 9944558163

e-mail : vcetcivil@gmail.com



Value Added Course on

***"Civil Engineering Drawing
and Bar Bending Scheduling"***

18th Nov 2021 to 06th Dec 2021

Convenor

Dr.E.Ravi, Prof.& Head/Civil

Course Coordinators

Mr.S.Suresh, AP/Civil

Mr.S.C.Sarathkumar, AP/Civil

Organized by

Department of Civil Engineering



**Velalar College of Engineering
and Technology
(Autonomous)**

(Accredited by NAAC with 'A' Grade)

Thindal, Erode - 638 012.

Phone : 0424 - 2244201 to 204 and 206

Fax : 0424-2244205

e-mail : vcetcivil@gmail.com

Website : www.velalarengg.ac.in

PRINCIPAL

**Velalar College of Engineering and Technology
(Autonomous)**

ERODE - 638 012.

S. P. S. 30/12/21

23
30

Name: U. Dhanya

Register number: 19CER003

Date: 30.12.2021

VELALAR COLLEGE OF ENGINEERING AND TECHNOLOGY

(An Autonomous Institution, Affiliated to Anna University, Chennai)

Value added course

**CIVIL ENGINEERING DRAWING AND BAR BENDING SCHEDULING DETAILING
OF REINFORCEMENT**

Sl. No.

Questions

1. The minimum diameter of longitudinal steel should be _____ mm
 - a) 10 mm
 - b) 12 mm
 - c) 8 mm
 - d) 14 mm
2. The spacing of longitudinal bars measured along the periphery of the column should not exceed _____
 - a) 200 mm
 - b) 250 mm
 - c) 300 mm
 - d) 350 mm
3. What is the effective length for the condition of effectively held in position and restrained against rotation in both ends of compression member _____.
 - a) 0.65l
 - b) 1.00l
 - c) 0.80l
 - d) 1.50l
4. The cross-sectional area of longitudinal reinforcement, shall be not less than _____ nor more than _____ of the gross cross-sectional area of the column
 - a) 0.6 % and 8%
 - b) 0.8 % and 6%
 - c) 0.6 % and 6%
 - d) 0.8 % and 8%
5. For a longitudinal reinforcing bar in the column nominal cover shall in any case not be less than _____.
 - a) 40mm
 - b) 20mm
 - c) 50mm
 - d) 60mm
6. Calculate the developmental length for M20 grade of concrete, Fe415, $C_{bd} = 1.92$, diameter of bar = 12 mm
7. Write the nominal cover for the following RCC elements
 - a) slab
 - b) beam
 - c) column
 - d) footing



PRINCIPAL
Velalar College of Engineering and Technology
(Autonomous)
ERODE - 638 012.

8. If length of bar is 12m with 10mm Dia then calculate the weight of bar _____
9. calculate the number of stirrups in a beam, length of the beam is 5 m and spacing between the stirrups is 200 mm
10. An RCC beam 350 mm wide and 500 mm deep with a length of 5000 mm is reinforced with four numbers of 12mm bars that are placed in one single row.

Out of the four bars, two of the bars are straight and two of the bars are bent up. Also, two additional anchor bars are provided on the top with a 10 mm diameter.

Stirrups of a diameter of 6 mm are provided at a c/c spacing of 150 mm. Determine the total quantity of steel required and the bar bending schedule.

11. calculate the length of the stirrups for the following cross sectional beam (200 mmx400 mm)
12. calculate the effective depth for the following cross sectional beam

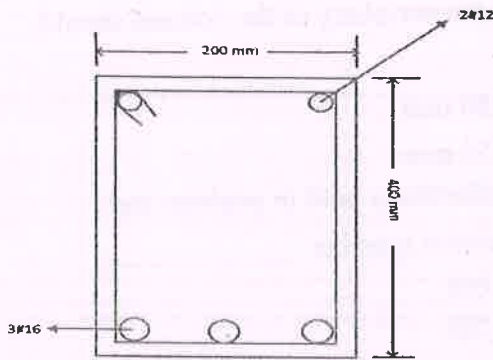

13. Determine the lap length for two bars in which the diameter of one bar is 25mm and another of diameter 40mm.
14. Calculate the length of torsional reinforcement of slab at corner? If $l_x = 4m$, $l_y = 3m$
15. Mention the bent up and curtailment length for the given slab

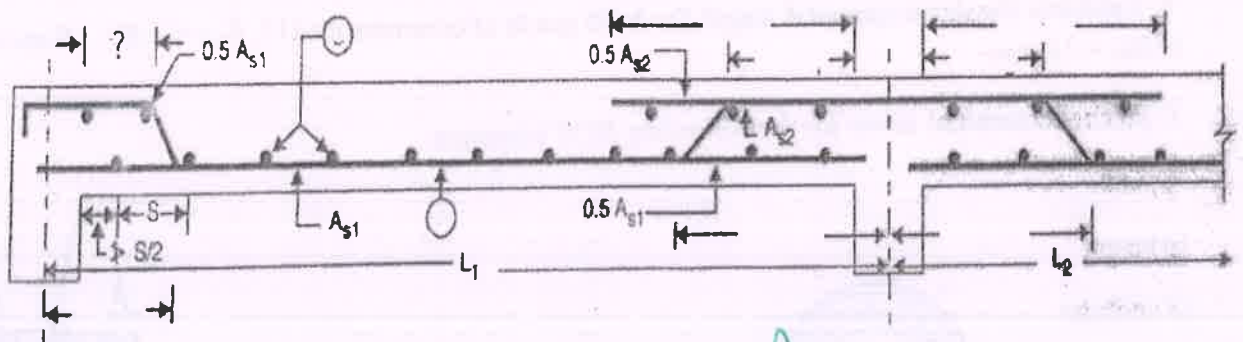

A. J. P.
PRINCIPAL
 Velalar College of Engineering and Technology
 (Autonomous)
 ERODE - 638 012.

U. Dhivya

Civil Engineering Drawing and Bar 18CE003
Bending Scheduling Detailing of Reinforcement
Value Added course.

1. b) 12mm ✓
2. c) 800mm ✓
3. a) 0.65L ✓
4. b) 0.8l and 6d ✓
5. a) 40mm ✓
6. Given

M20, Fe 415

$$l_{bd} = 1.92$$

$$\phi = 12\text{mm}$$

$$\text{Developmental length } L_D = \frac{\phi \sigma_s}{4 \tau_{bd}} = \frac{\phi \times 0.87 \times f_y}{4 \times \tau_{bd}} = 56.6\text{cm}$$

$$L_D = 56.6\text{cm}$$

7) Nominal cover

a) Slab = 20mm

b) beam = 25mm

c) column = 40mm

d) footing = 50mm

8) Given length of bar = 12m
 $\phi = 10\text{mm}$



$$\text{weight of bar per metre} = 0.617\text{ kg}$$

$$\text{weight of bar for 12 metre} = 7.4\text{ kg}$$

[Signature]

PRINCIPAL

Velalar College of Engineering and Technology
(Autonomous)
ERODE - 638 012.

9) Given

length of beam = 5m

Spacing = 200mm

number of stirrups = $\frac{\text{length}}{\text{Spacing}} + 1 = \frac{5}{0.2} + 1 = 26$

12) Effective depth, d = 315mm.

11) length of stirrups = (0.15 + 0.15 + 0.35 + 0.35 + 0.1) = 1.1m.

14) length of torsional reinforcement = $\frac{L_2}{5} = \frac{4}{5} = 0.8m$.

13) Lap length = 50d = 1250mm

15)

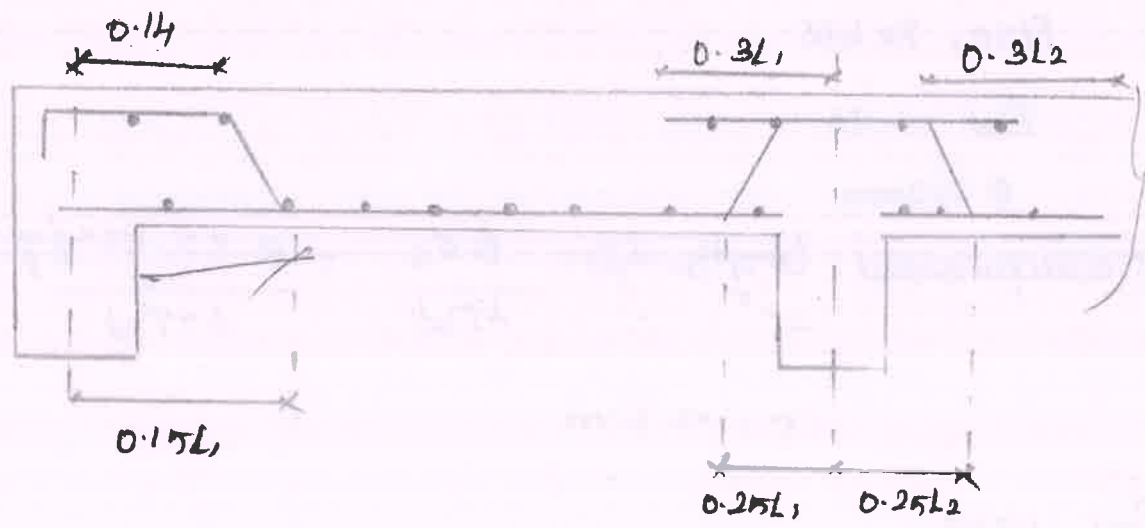

Handwritten signature in green ink.

PRINCIPAL
Velalar College of Engineering and Technology
(Autonomous)
ERODE - 638

8. If length of bar is 12m with 10mm Dia then calculate the weight of bar _____
9. calculate the number of stirrups in a beam, length of the beam is 5 m and spacing between the stirrups is 200 mm
10. An RCC beam 350 mm wide and 500 mm deep with a length of 5000 mm is reinforced with four numbers of 12mm bars that are placed in one single row.

Out of the four bars, two of the bars are straight and two of the bars are bent up. Also, two additional anchor bars are provided on the top with a 10 mm diameter.

Stirrups of a diameter of 6 mm are provided at a c/c spacing of 150 mm. Determine the total quantity of steel required and the bar bending schedule.

11. calculate the length of the stirrups for the following cross sectional beam (200 mmx400 mm)
12. calculate the effective depth for the following cross sectional beam

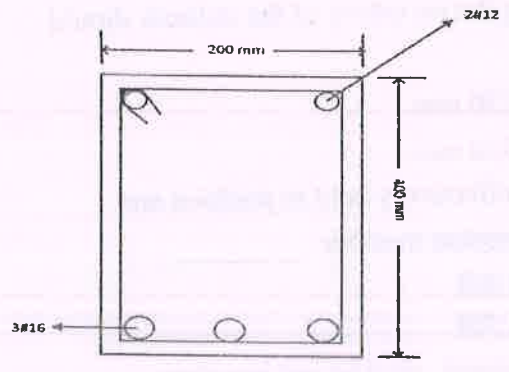

13. Determine the lap length for two bars in which the diameter of one bar is 25mm and another of diameter 40mm.
14. Calculate the length of torsional reinforcement of slab at corner? If $l_x = 4m$, $l_y = 3m$
15. Mention the bent up and curtailment length for the given slab

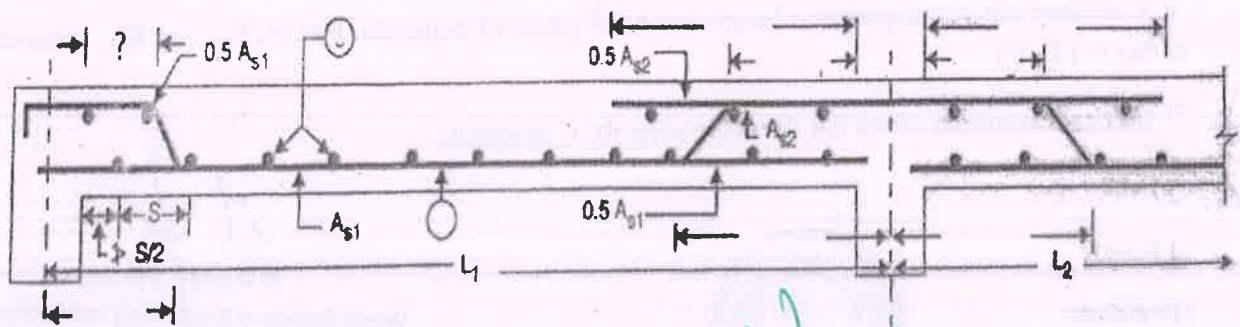

PRINCIPAL
 Velalar College of Engineering and Technology
 (Autonomous)
 ERODE - 638 012.

Civil Engineering Drawing And Bar Bending Scheduling Detailing of Reinforcement.

30-12-2021

1). b) 12 mm ✓

2). c) 300 mm ✓

3). a) 0.65 l ✓

4). b) 0.8 l and 6 l ✓

5). a) 40 mm ✓

6. Given:

M_{20} , F_{e415}

$L_{bd} = 1.92$

$\phi = 12 \text{ mm}$

$$\text{Developmental length } L_D = \frac{\phi \sigma_s}{4 \tau_{bd}}$$

$$= \frac{\phi \times 0.87 f_y}{4 \times \tau_{bd}}$$

$$= \frac{12 \times 0.87 \times 415}{4 \times 1.92}$$

$$L_D = 56.4 \text{ cm}$$



Signature
PRINCIPAL
 Vaidar College of Engineering and Technology
 (Autonomous)
 ERODE - 638 012.

7).

nominal cover

a) Slab - 20 mm

b). beam - 25 mm

c). Column - 40 mm

d). footing - 50 mm

8.

Given

$$\text{length of bar} = 12 \text{ m}$$

$$\phi = 10 \text{ mm}$$

$$\text{Weight of bar per meter} = 0.617 \text{ kg}$$

$$\text{Weight of bar for 12 meters} = 7.4 \text{ kg}$$

9. Given:-

$$\text{Length of beam} = 5 \text{ m}$$

$$\text{Spacing} = 200 \text{ mm}$$

$$\text{number of stirrups} = \frac{\text{Length}}{\text{Spacing}} + 1$$

$$= \frac{5}{0.2} + 1$$

$$\text{number of stirrups} = 26$$

11.

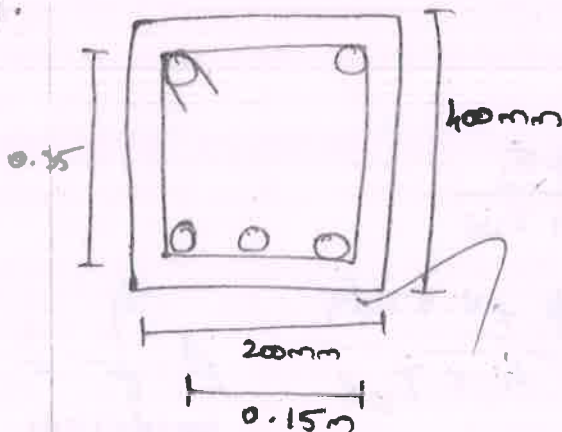

$$\text{Length of stirrups} = (0.15 + 0.15 + 0.35 + 0.35 + 0.1)$$

$$\text{Length of stirrups} = 1.1 \text{ m}$$

12.

$$\text{Effective depth, } d = 375 \text{ mm}$$

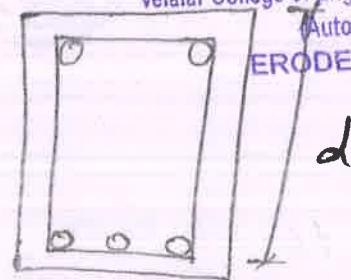

PRINCIPAL

Velalar College of Engineering and Technology

(Autonomous)

ERODE - 638 012.

13.

$$\text{Lap length} = 50d$$

$$= 50(25)$$

$$= 1250 \text{ mm}$$

choose which ever dia is minimum

14. Length of torsional reinforcement = $\frac{Ld}{5}$

$$= \frac{4}{5}$$

$$= 0.8 \text{ mm}$$

15.

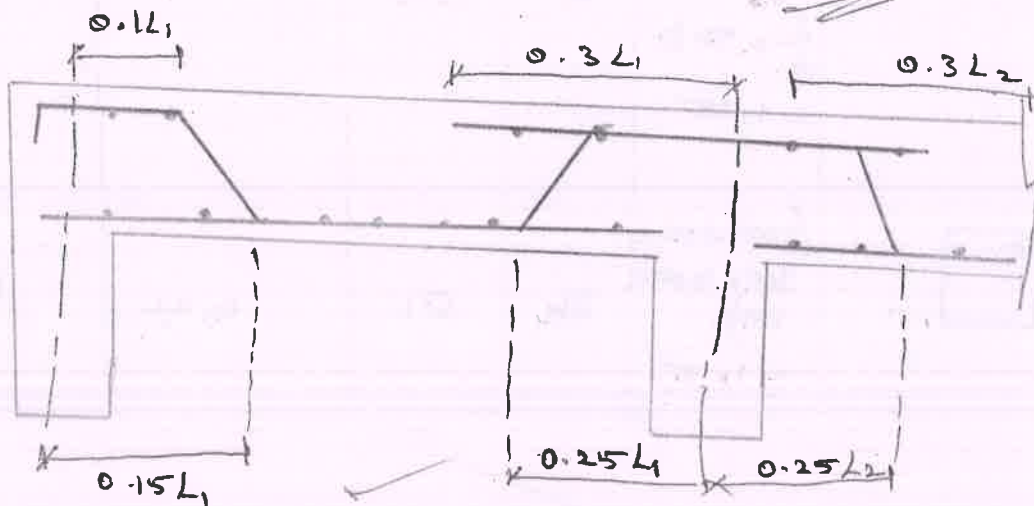

10.

Given :-

$$L = 5 \text{ m}$$

$$d = 450 \text{ mm}$$





$$b = 350 \text{ mm}$$

$$\text{Cover} = 25 \text{ mm}$$

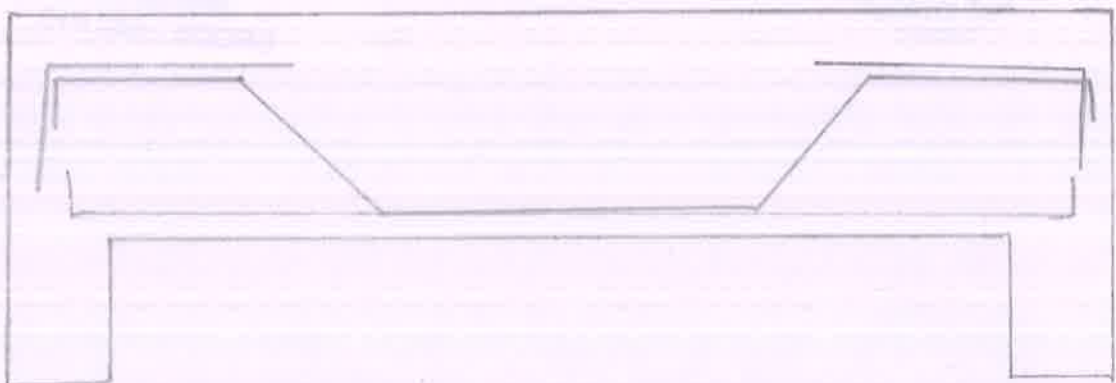

(Signature)
PRINCIPAL
 Velalar College of Engineering and Technology
 (Autonomous)
 ERODE - 638 012.

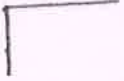

Dia	Shape	Length (m)	No. of bars	Total length	Weight of bar kg/m	Total Wt. kg
#D ₁₂		$(5 - 0.05)$ $+ 0.225$ $+ 0.225$ $= 5.4$	2	10.8	0.88	9.6
#D ₁₂						
#D ₁₀		$(\frac{L}{4} + 50D)$ $= 1.75$	2	3.5	0.62	2.16
#D ₆		$(400 + 400 + 300 + 300 + 100)$ $= 1.5$	34	51	0.22	11.33



PRINCIPAL
 Velalar College of Engineering and Technology
 (Autonomous)
 ERODE - 638 012.

Dr. R. Jeevitha
30/12/21

26
30

Name: R. Jeevitha

Register number: 18CER009

Date: 30.12.2021

VELALAR COLLEGE OF ENGINEERING AND TECHNOLOGY

(An Autonomous Institution, Affiliated to Anna University, Chennai)

Value added course

CIVIL ENGINEERING DRAWING AND BAR BENDING SCHEDULING DETAILING OF REINFORCEMENT

Sl. No.

Questions

1. The minimum diameter of longitudinal steel should be _____ mm
 - a) 10 mm
 - b) 12 mm
 - c) 8 mm
 - d) 14 mm
2. The spacing of longitudinal bars measured along the periphery of the column should not exceed _____
 - a) 200 mm
 - b) 250 mm
 - c) 300 mm
 - d) 350 mm
3. What is the effective length for the condition of effectively held in position and restrained against rotation in both ends of compression member _____
 - a) 0.65l
 - b) 1.00l
 - c) 0.80l
 - d) 1.50l
4. The cross-sectional area of longitudinal reinforcement, shall be not less than _____ nor more than _____ of the gross cross-sectional area of the column
 - a) 0.6 % and 8%
 - b) 0.8 % and 6%
 - c) 0.6 % and 6%
 - d) 0.8 % and 8%
5. For a longitudinal reinforcing bar in the column nominal cover shall in any case not be less than _____
 - a) 40mm
 - b) 20mm
 - c) 50mm
 - d) 60mm
6. Calculate the developmental length for M20 grade of concrete, Fe415, $C_{bd} = 1.92$, diameter of bar = 12 mm
7. Write the nominal cover for the following RCC elements
 - a) slab
 - b) beam
 - c) column
 - d) footing



R. Jeevitha
PRINCIPAL
Velalar College of Engineering and Technology
(Autonomous)
ERODE - 638 012.

8. If length of bar is 12m with 10mm Dia then calculate the weight of bar _____
9. calculate the number of stirrups in a beam, length of the beam is 5 m and spacing between the stirrups is 200 mm
10. An RCC beam 350 mm wide and 500 mm deep with a length of 5000 mm is reinforced with four numbers of 12mm bars that are placed in one single row.

Out of the four bars, two of the bars are straight and two of the bars are bent up. Also, two additional anchor bars are provided on the top with a 10 mm diameter.

Stirrups of a diameter of 6 mm are provided at a c/c spacing of 150 mm. Determine the total quantity of steel required and the bar bending schedule.

11. calculate the length of the stirrups for the following cross sectional beam (200 mmx400 mm)
12. calculate the effective depth for the following cross sectional beam

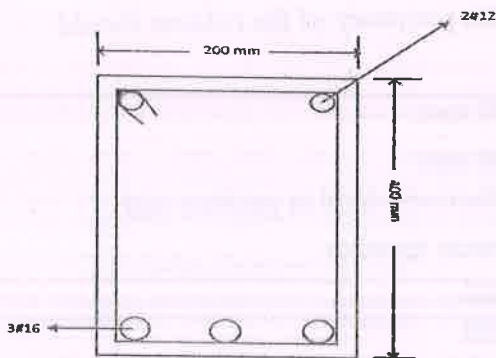

13. Determine the lap length for two bars in which the diameter of one bar is 25mm and another of diameter 40mm.
14. Calculate the length of torsional reinforcement of slab at corner? If $l_x = 4m$, $l_y = 3m$
15. Mention the bent up and curtailment length for the given slab

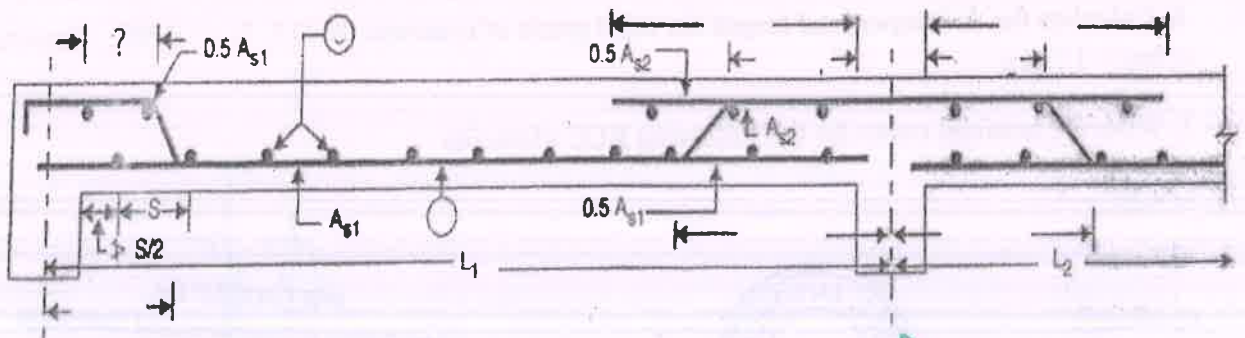

Value added course

R. Jeeritha
18CER009

1. b) 12mm ✓
2. c) 300mm ✓
3. a) 0.65I ✓
4. b) 0.8% and 6% ✓
5. a) 40mm ✓
6. Given:

M20 grade concrete

Fe415

$$\tau_{bd} = 1.92$$

$$\phi = 12 \text{ mm}$$

$$L_d = \frac{\phi \sigma_s}{4 \tau_{bd}}$$

$$\sigma_s = 0.87 f_y = 0.87 \times 415 =$$

$$L_d = \frac{12 \times 0.87 \times 415}{4 \times 1.92}$$

$$L_d = 56.4 \text{ cm}$$

7. Nominal cover

a) Slab = 20mm

b) Beam = 25mm

c) Column = 30-40mm

d) Footing = 50mm - 75mm



PRINCIPAL
Velalar College of Engineering and Technology
(Autonomous)
ERODE - 638 012.

8. Length of bar = 12 m

Dia of bar = 10 mm

Weight of bar per meter for 10 mm = 0.617 Kg

Weight of bar (12m) = 7.4 Kg

9. Length of the beam = 5 m

Spacing b/w stirrups = 200 mm

$$\text{Number of stirrups} = \frac{\text{span}}{\text{spacing}} + 1$$

$$= \frac{5}{0.2} + 1$$

Number of stirrups in a beam = 26 Nos.

11.

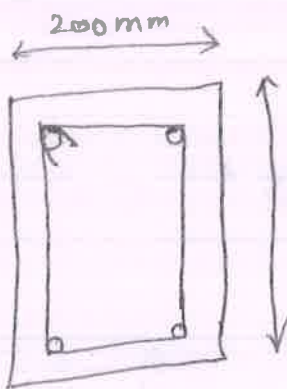

$$= 0.2 - 0.05 = 0.15 \text{ m}$$

$$= 0.4 - 0.05 = 0.35 \text{ m}$$

Length of stirrups = 0.15 + 0.15 + 0.35 + 0.35 + 0.1

$$= 1.1 \text{ m}$$



12. Effective depth = 375 mm

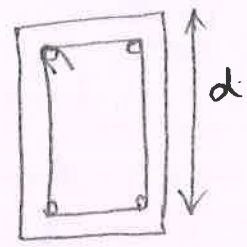

13. Lap length = 50d

Consider lesser diameter of bar among two

= 50 x 25

Lap length = 1250 mm

14. Torsional reinforcement of slab

$l_x = 4m, l_y = 3m.$

Length of torsional = $\frac{L_x}{5}$ (or) $0.2 L_x$
= 0.8 m

15.

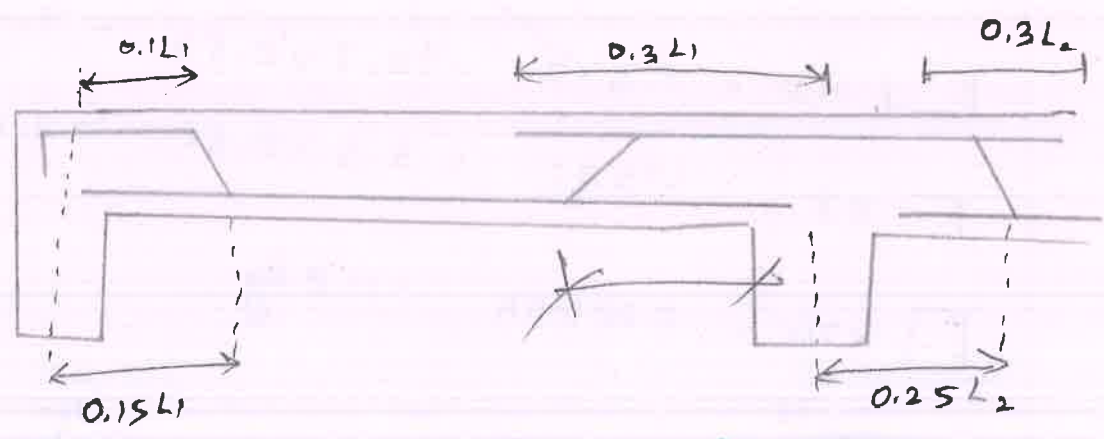

PRINCIPAL
Velalar College of Engineering and Technology
(Autonomous)
ERODE 638 012.

10.

Given :

$$L = 5 \text{ m}$$

$$d = 450 \text{ mm}$$

$$b = 350 \text{ mm}$$

$$\text{Cover} = 25 \text{ mm}$$

Straight bar

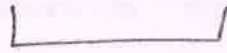

$$= (5 - 0.05) + 0.225 + 0.225$$

$$= 5.4 \text{ m}$$

Anchor bar



$$= \frac{L}{4} + 50D$$

$$= \frac{5}{4} + (50 \times 0.01)$$

$$= 1.75 \text{ m}$$

$$\text{Stirrup} = \left(\frac{5}{0.15} + 1 \right) = 34 \text{ NOS}$$

$$\square \times 2 = 5.4 \times 2 = 10.8 \times 0.88 \text{ weight} = 9.6 \text{ Kg}$$

$$\Gamma \times 2 = 1.75 \times 2 = 3.5 \times 0.62 = 2.16 \text{ Kg}$$

$$\square \times 34 = 0.22 \times 54 = 11.8 \text{ Kg}$$



PRINCIPAL
Velalar College of Engineering and Technology
(Autonomous)
ERODE - 638 012.

S. Sub
30/12/21

24
30

Name: VIVEKA .V

Register number: 18CER028

Date: 30/12/21

VELALAR COLLEGE OF ENGINEERING AND TECHNOLOGY

(An Autonomous Institution, Affiliated to Anna University, Chennai)

Value added course

CIVIL ENGINEERING DRAWING AND BAR BENDING SCHEDULING DETAILING OF REINFORCEMENT

Sl. No.

Questions

1. The minimum diameter of longitudinal steel should be _____ mm
 - a) 10 mm
 - b) 12 mm
 - c) 8 mm
 - d) 14 mm
 2. The spacing of longitudinal bars measured along the periphery of the column should not exceed _____
 - a) 200 mm
 - b) 250 mm
 - c) 300 mm
 - d) 350 mm
 3. What is the effective length for the condition of effectively held in position and restrained against rotation in both ends of compression member _____
 - a) 0.65l
 - b) 1.00l
 - c) 0.80l
 - d) 1.50l
 4. The cross-sectional area of longitudinal reinforcement, shall be not less than _____ nor more than _____ of the gross cross-sectional area of the column
 - a) 0.6 % and 8%
 - b) 0.8 % and 6%
 - c) 0.6 % and 6%
 - d) 0.8 % and 8%
 5. For a longitudinal reinforcing bar in the column nominal cover shall in any case not be less than _____
 - a) 40mm
 - b) 20mm
 - c) 50mm
 - d) 60mm
6. Calculate the developmental length for M20 grade of concrete, Fe415, $C_{bd} = 1.92$, diameter of bar = 12 mm
7. Write the nominal cover for the following RCC elements
- a) slab
 - b) beam
 - c) column
 - d) footing



PRINCIPAL

Velalar College of Engineering and Technology
(Autonomous)

ERODE - 638 012.

8. If length of bar is 12m with 10mm Dia then calculate the weight of bar _____
9. calculate the number of stirrups in a beam, length of the beam is 5 m and spacing between the stirrups is 200 mm
10. An RCC beam 350 mm wide and 500 mm deep with a length of 5000 mm is reinforced with four numbers of 12mm bars that are placed in one single row.

Out of the four bars, two of the bars are straight and two of the bars are bent up. Also, two additional anchor bars are provided on the top with a 10 mm diameter.

Stirrups of a diameter of 6 mm are provided at a c/c spacing of 150 mm. Determine the total quantity of steel required and the bar bending schedule.

11. calculate the length of the stirrups for the following cross sectional beam (200 mmx400 mm)
12. calculate the effective depth for the following cross sectional beam

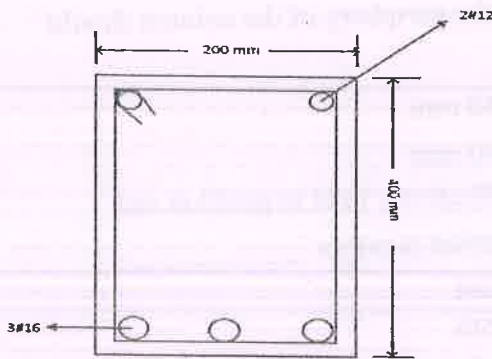

13. Determine the lap length for two bars in which the diameter of one bar is 25mm and another of diameter 40mm.
14. Calculate the length of torsional reinforcement of slab at corner? If $l_x = 4m$, $l_y = 3m$
15. Mention the bent up and curtailment length for the given slab

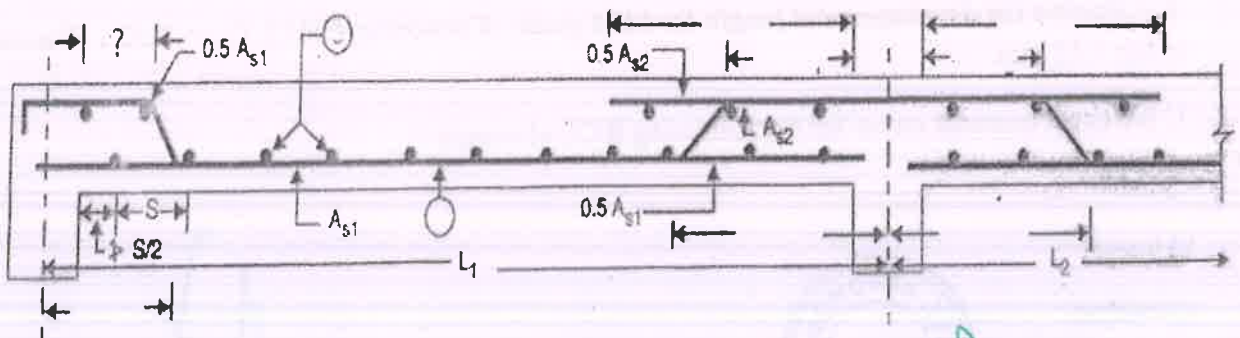

PRINCIPAL
 Velalar College of Engineering and Technology
 (Autonomous)
 ERODE - 638 012.

Civil Engineering Drawing And Bar Bending Scheduling Detailing of Reinforcement Value Added Course

V. Viveka
18CE R028

- 1) b) 12 mm
- 2) c) 300 mm
- 3) a) 0.65 L
- 4) b) 0.8 % and 6 %
- 5) a) 40 mm

6) Given

M₂₀ grade, Fe415

$$\tau_{bd} = 1.92$$

$$\phi = 12 \text{ mm}$$

$$\text{Development Length, } L_D = \frac{\phi \sigma_s}{4 \tau_{bd}} = \frac{\phi \times 0.87 \times f_y}{4 \times 1.92}$$

$$L_D = 56.6 \text{ cm}$$

7) Nominal Covers

a) Slab = 20 mm

b) Beam

c) Column

d) footing = 50 mm



V. Viveka
PRINCIPAL
Velalar College of Engineering and Technology
(Autonomous)
ERODE - 638 012.

8) Given

length of Bar = 12 m

$\phi = 10 \text{ mm}$

Wgt of bar per meter = 0.617 kg

Wgt of bar for 12 m = 7.4 kg

9) Given :

length of Beam = 5 m

Spacing = 200 mm

No. of stirrups = $\frac{\text{length}}{\text{Spacing}} + 1$

$$= \frac{5}{0.2} + 1 = 26$$

12) Effective depth = 375 mm

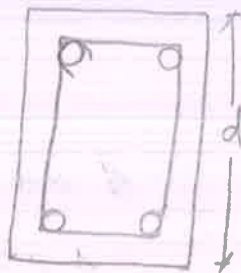

13) Lap length = $50d$

Consider lesser diameter of bar Among two = 50×25

Lap length = 1250 mm

14) Torsional Reinforcement of slab



4m, $l_y = 3 \text{ m}$

length of Torsional = $L_x/5$ (or) 0.2

= 0.8 m

PRINCIPAL
Velalar College of Engineering and Technology
(Autonomous)
ERODE - 638 012.

ii)

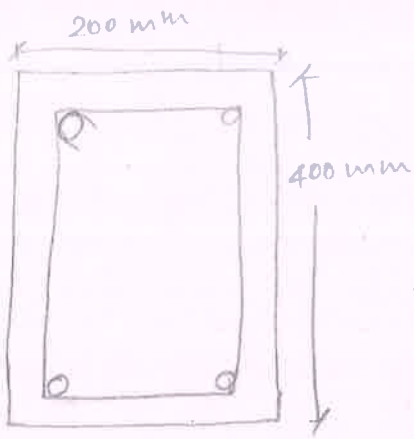

$$= 0.2 - 0.05 = 0.15 \text{ m}$$

$$= 0.4 - 0.05 = 0.35 \text{ m}$$

length of stirrups = $0.15 + 0.15 + 0.35 + 0.35 + 0.1$
 $= 1.1 \text{ m}$

b)

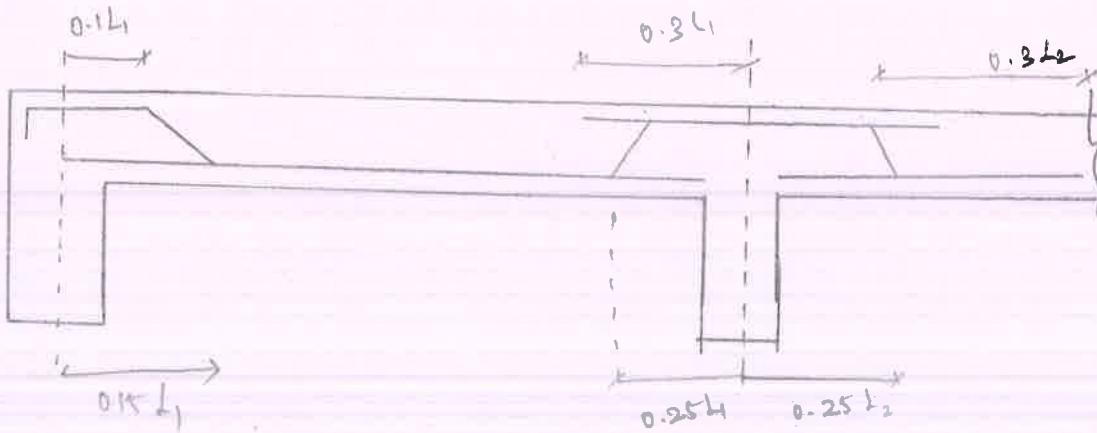

Dia	shape	length	No. of bar	Total length	Wgt of bar kg/m	Total Wgt
12 mm		$(5 - 0.05)$ $+ 0.225$ $+ 0.225$ $= 5.4$	2	10.8	0.88	9.6
6 mm		1.5	34	51	0.22	11.32



PRINCIPAL
 Velalar College of Engineering and Technology
 (Autonomous)
 ERODE - 638 012.

g. Sub
30/12/21
25
30

Name: A. Subvetha

Register number: 18CER026

Date: 30/12/2021

VELALAR COLLEGE OF ENGINEERING AND TECHNOLOGY

(An Autonomous Institution, Affiliated to Anna University, Chennai)

Value added course

CIVIL ENGINEERING DRAWING AND BAR BENDING SCHEDULING DETAILING OF REINFORCEMENT

Sl. No.

Questions

1. The minimum diameter of longitudinal steel should be _____ mm
 - a) 10 mm
 - b) 12 mm
 - c) 8 mm
 - d) 14 mm
2. The spacing of longitudinal bars measured along the periphery of the column should not exceed _____
 - a) 200 mm
 - b) 250 mm
 - c) 300 mm
 - d) 350 mm
3. What is the effective length for the condition of effectively held in position and restrained against rotation in both ends of compression member _____.
 - a) 0.65l
 - b) 1.00l
 - c) 0.80l
 - d) 1.50l
4. The cross-sectional area of longitudinal reinforcement, shall be not less than _____ nor more than _____ of the gross cross-sectional area of the column
 - a) 0.6 % and 8%
 - b) 0.8 % and 6%
 - c) 0.6 % and 6%
 - d) 0.8 % and 8%
5. For a longitudinal reinforcing bar in the column nominal cover shall in any case not be less than _____.
 - a) 40mm
 - b) 20mm
 - c) 50mm
 - d) 60mm
6. Calculate the developmental length for M20 grade of concrete, Fe415, $C_{bd} = 1.92$, diameter of bar = 12 mm
7. Write the nominal cover for the following RCC elements
 - a) slab
 - b) beam
 - c) column
 - d) footing



A. Subvetha
PRINCIPAL
Velalar College of Engineering and Technology
(Autonomous)
ERODE - 638 012.

8. If length of bar is 12m with 10mm Dia then calculate the weight of bar _____
9. calculate the number of stirrups in a beam, length of the beam is 5 m and spacing between the stirrups is 200 mm
10. An RCC beam 350 mm wide and 500 mm deep with a length of 5000 mm is reinforced with four numbers of 12mm bars that are placed in one single row.

Out of the four bars, two of the bars are straight and two of the bars are bent up. Also, two additional anchor bars are provided on the top with a 10 mm diameter.

Stirrups of a diameter of 6 mm are provided at a c/c spacing of 150 mm. Determine the total quantity of steel required and the bar bending schedule.

11. calculate the length of the stirrups for the following cross sectional beam (200 mmx400 mm)
12. calculate the effective depth for the following cross sectional beam

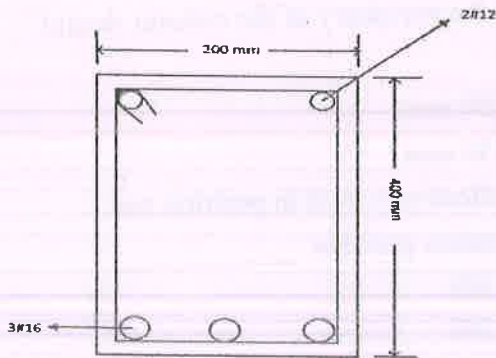

13. Determine the lap length for two bars in which the diameter of one bar is 25mm and another of diameter 40mm.
14. Calculate the length of torsional reinforcement of slab at corner? If $l_x = 4m$, $l_y = 3m$
15. Mention the bent up and curtailment length for the given slab

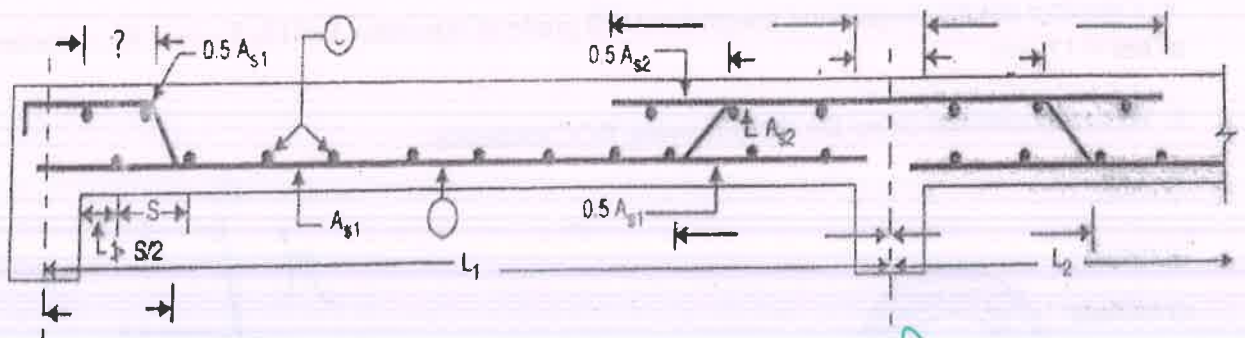

[Signature]
PRINCIPAL
 Velatar College of Engineering and Technology
 (Autonomous)
 ERODE - 638 012.

CIVIL ENGINEERING DRAWING AND BAR-BENDING
SCHEDULING DETAILING OF REINFORCEMENT.

VALUE ADDED COURSE

P. Suvetha
18CER026

① b) 12 mm

② c) 300 mm

③ a) 0.65 L

④ b) 0.8% and 6%.

⑤ a) 40 mm

⑥ given:

M20, Fe 415

$T_{bd} = 1.92$

$\phi = 12 \text{ mm}$

$$\text{Development length } L_d = \frac{\phi \sigma_s}{4 T_{bd}} = \frac{\phi \times 0.87 f_y}{4 \times T_{bd}} = 56.6 \text{ cm}$$

$$L_d = 56.6 \text{ cm}$$

⑦ Nominal cover:

a) slab = 20 mm

b) beam = 25 mm

c) column = 40 mm

d) footing = 50 mm

⑧ given:



Length of bar = 12 m

$\phi = 10 \text{ mm}$

Weight of bar per meter = 0.617 Kg

P. Suvetha

PRINCIPAL

Velalar College of Engineering and Technology
(Autonomous)

ERODE - 638 012.

weight of bar for 12m = 7.4 kg

9) given:

Length of beam = 5m

spacing = 200 mm

$$\text{Number of stirrups} = \frac{\text{Length}}{\text{spacing}} + 1 = \frac{5}{0.2} + 1 = 26$$

11)

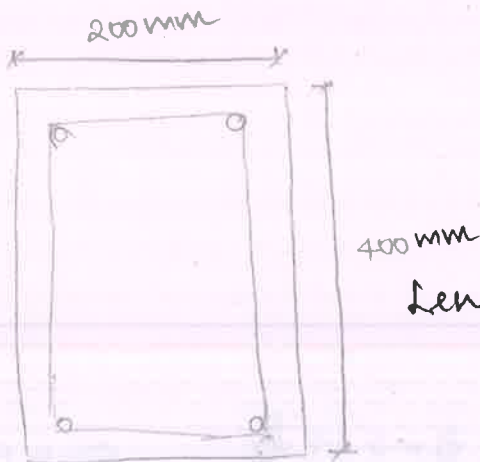

$$= 0.2 - 0.05 = 0.15 \text{ m}$$

$$= 0.4 - 0.05 = 0.35 \text{ m}$$

$$\text{Length of stirrups} = 0.15 + 0.15 + 0.35 + 0.35 + 0.1$$

$$= 1.1 \text{ m}$$

$$\text{Effective depth} = 375 \text{ mm}$$

12)

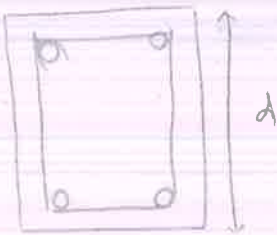

13)

Lap length = 50d

consider lesser diameter of bar among two = 50 x 25

$$\text{Lap length} = 1250 \text{ mm}$$

14)

Torsional reinforcement of slab

$$l_x = 4 \text{ m}, l_y = 3 \text{ m}$$

$$\text{Length of torsional} = \frac{l_x}{5} \text{ (or) } 0.2 l_x$$



$$= 0.8 \text{ m}$$

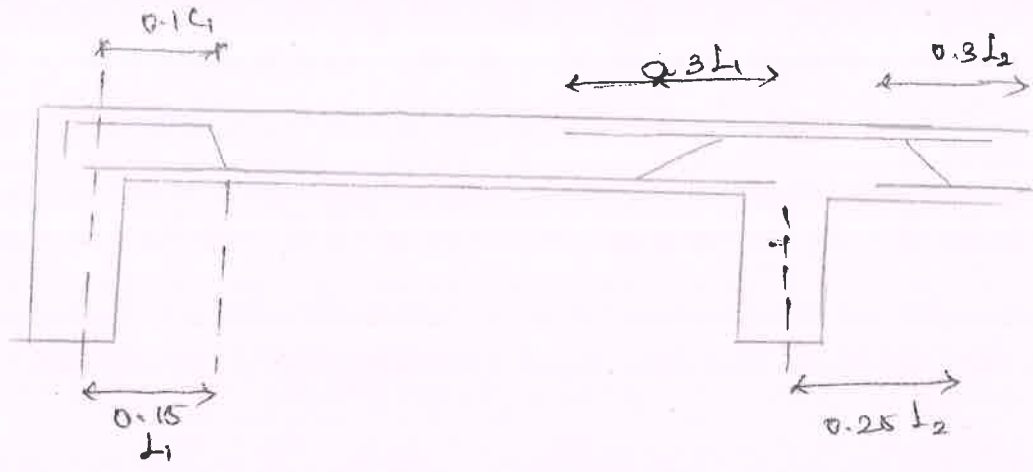

15

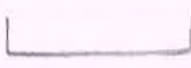

10

Dia	Shape	Length	No. of bar	Total Length	weight of bar kg/m	Total wgt
# D ₂		$(5 - 0.05)$ $+ 0.225$ $+ 0.225$ $= 5.4$	2	10.8	0.88	9.6
# D ₆		1.5	34	51	0.22	11.33



[Handwritten signature]

PRINCIPAL
 Velalar College of Engineering and Technology
 (Autonomous)
 ERODE - 638 012.

8. If length of bar is 12m with 10mm Dia then calculate the weight of bar _____
9. calculate the number of stirrups in a beam, length of the beam is 5 m and spacing between the stirrups is 200 mm
10. An RCC beam 350 mm wide and 500 mm deep with a length of 5000 mm is reinforced with four numbers of 12mm bars that are placed in one single row.
- Out of the four bars, two of the bars are straight and two of the bars are bent up. Also, two additional anchor bars are provided on the top with a 10 mm diameter.
- Stirrups of a diameter of 6 mm are provided at a c/c spacing of 150 mm. Determine the total quantity of steel required and the bar bending schedule.
11. calculate the length of the stirrups for the following cross sectional beam (200 mmx400 mm)
12. calculate the effective depth for the following cross sectional beam

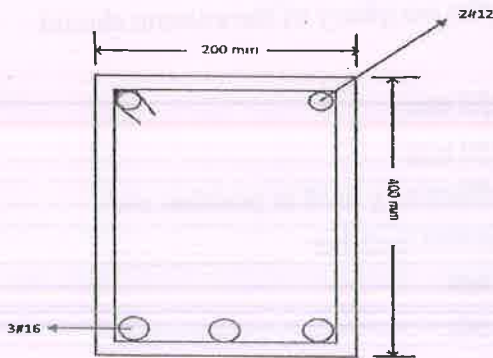

13. Determine the lap length for two bars in which the diameter of one bar is 25mm and another of diameter 40mm.
14. Calculate the length of torsional reinforcement of slab at corner? If $l_x = 4m$, $l_y = 3m$
15. Mention the bent up and curtailment length for the given slab

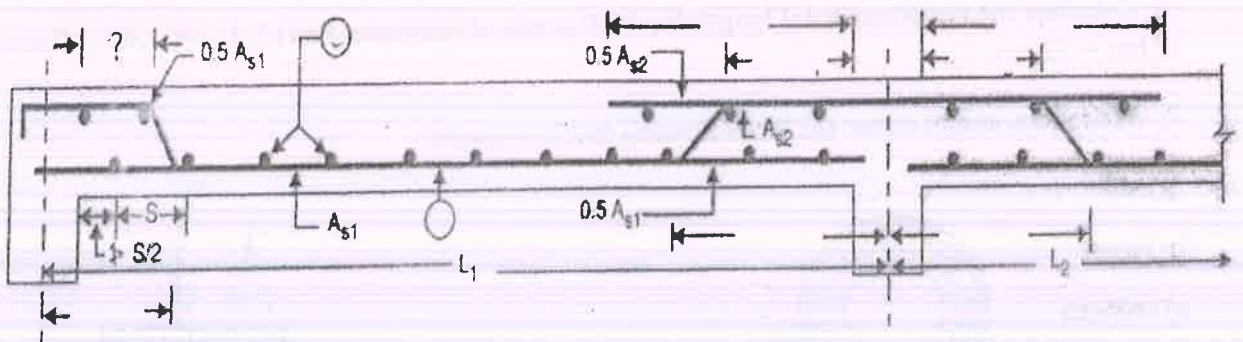

Value added course.

Civil Engineering Drawing and Bar Bending scheduling
Detailing of Reinforcement.

1. b) 12mm ✓
2. c) 300mm ✓
3. a) 0.65 ✓
4. b) 0.8% and 6% ✓
5. a) 40mm ✓
6. Gen:-

M20, F2415

 $\tau_{bd} = 1.92$ $\phi = 12\text{mm}$

$$\text{Development length } L_D = \frac{\phi \sigma_s}{4 \tau_{bd}}$$

$$L_D = \frac{d \times 0.87 f_y}{4 \tau_{bd}} = 56.3\text{cm}$$

7. Nominal cover:

- a) Slab - 20mm
- b) Beam - 25mm
- c) Column - 40mm
- d) Footing - 50mm ✓

8. Gen:-

Length of bar = 12m

 $\phi = 10\text{mm}$

Weight of bar per metre = 0.617 kg

Weight of bar for 12 metre = 7.4 kg



PRINCIPAL
Velalar College of Engineering and Technology
(Autonomous)
ERODE - 638 012.

9. Gm:-

Length of beam = 5m

spacing = 200mm

$$\text{Number of stirrups} = \frac{\text{length}}{\text{spacing}} + 1 = 26.$$

12. Effective depth, $d = 375$ mm.

11. Length of stirrups = 1.1m

14. Length of torsional reinforcement = $\frac{L \times}{5}$
= 0.8m

13. Lap length = 50d
= 1250mm



PRINCIPAL

Velalar College of Engineering and Technology
(Autonomous)

ERODE - 638 012.

VELALAR COLLEGE OF ENGINEERING AND TECHNOLOGY
DEPARTMENT OF CIVIL ENGINEERING
VALUE ADDED COURSE on
Civil Engineering Drawing and Bar Bending Scheduling
Marksheet

CLASS:18CE7

BATCH:2018-22

S.No	Reg. No.	Name of the Student	Marks
1	18CEA001	VIJAYARANGAN V	88
2	18CEL001	EDWIN.J	90
3	18CEL002	GOKULAKRISHNAN.C	93
4	18CEL003	MOHANSHYAM.T	92
5	18CEL004	SANTHOSH T K	83
6	18CEL005	R.SANTHOSH KUMAR	95
7	18CEL006	SATHEESH KUMAR.S	87
8	18CEL007	S.YOGESH	95
9	18CER001	DEVANATHAN A.P	92
10	18CER002	DHARANI V N	98
11	18CER003	A.DHIVYA	98
12	18CER004	R.S.DIVAGAR	93
13	18CER005	M.HARITHA	92
14	18CER006	HRITHIK.K	92
15	18CER007	R.JAYAMAHIMA	93
16	18CER008	JEEVANANDHAM.G	88
17	18CER009	JEEVITHA R	98
18	18CER010	KABILAN.PL	92
19	18CER011	MATHESH.R	97
20	18CER012	P.MAYURII	98
21	18CER013	MOHANAPRASHANTH B	97
22	18CER015	NITHEESKUMAR.R	95
23	18CER016	RAGESH R	87
24	18CER017	S.RANJITHKUMAR	92
25	18CER018	SHIVASHANGAR. M	88
26	18CER019	SIJIN.S	92
27	18CER020	D. SIVARANJANI	98
28	18CER021	C.SOWMITHA	93
29	18CER023	V.SRIPATHI	90
30	18CER024	SUBHIKSHA. G. R	98
31	18CER025	P.E.SURESH	90
32	18CER026	S.SUVETHA	98
33	18CER027	A.SWATHI PRIYA	95
34	18CER028	V.VIVEKA	98

P. Chandrasekhar
VAC Coordinator(s)

[Signature]
HOD/Civil

[Signature]
PRINCIPAL
Velalar College of Engineering and Technology
(Autonomous)
ERODE - 638 012.



VELALAR COLLEGE OF ENGINEERING AND TECHNOLOGY

Department of Civil Engineering

Value Added Course – Student Feedback Form

Date: 06.12.21

Register No: 18CE025

Student Name: SURESH.P.E

Title of the course: Civil Engineering drawing and bar bending scheduling

	Strongly Agree	Agree	Neutral	Disagree	Strongly Disagree
1.The objective of the course were clearly defined.	<input checked="" type="checkbox"/>				
2. Participation and interaction was encouraged.		<input checked="" type="checkbox"/>			
3. The topics covered were relevant to course.	<input checked="" type="checkbox"/>				
4. The content was organized and easy to follow.	<input checked="" type="checkbox"/>				
5. Was the material presented clearly and understandable?		<input checked="" type="checkbox"/>			
6. Did you find it easy to navigate through the program?	<input checked="" type="checkbox"/>				
7. The course objectives were met.	<input checked="" type="checkbox"/>				
8. The time allotted for the course was sufficient.	<input checked="" type="checkbox"/>				

9. Would you enrol in refresh course in the same topic? **Yes/No** (Tick your answer)

10. Additional trainings would you like to have in the future? **Yes/No** (Tick your answer)

11. Do you have any suggestions that would help us improve the quality of our course?

No



PRINCIPAL
Velalar College of Engineering and Technology
(Autonomous)
ERODE - 638 012.

Thank you for your feedback

18CER021
Sivarangani

VELALAR COLLEGE OF ENGINEERING AND TECHNOLOGY

Department of Civil Engineering

Value Added Course – Student Feedback Form

06.12.21

Date: 06.12.21

Register No: 18CER021

Student Name: Sivarangani

Title of the course: Civil Engineering drawing and bar bending scheduling

	Strongly Agree	Agree	Neutral	Disagree	Strongly Disagree
1. The objective of the course were clearly defined.	✓				
2. Participation and interaction was encouraged.		✓			
3. The topics covered were relevant to course.	✓				
4. The content was organized and easy to follow.	✓				
5. Was the material presented clearly and understandable?	✓				
6. Did you find it easy to navigate through the program?		✓			
7. The course objectives were met.	✓				
8. The time allotted for the course was sufficient.	✓				
9. Would you enrol in refresh course in the same topic? Yes/No (Tick your answer)	✓				
10. Additional trainings would you like to have in the future? Yes/No (Tick your answer)	✓				
11. Do you have any suggestions that would help us improve the quality of our course?	Need more practical classes.				



PRINCIPAL
Velalar College of Engineering and Technology
(Autonomous)
ERODE - 638 012.

Thank you for your feedback

VELALAR COLLEGE OF ENGINEERING AND TECHNOLOGY

Department of Civil Engineering

Value Added Course – Student Feedback Form

Date: 06.12.2021

Register No: 18CEER002

Student Name: DHARANI.D

Title of the course: Civil Engineering drawing and bar bending scheduling

	Strongly Agree	Agree	Neutral	Disagree	Strongly Disagree
1. The objective of the course were clearly defined.	✓				
2. Participation and interaction was encouraged.	✓				
3. The topics covered were relevant to course.	✓				
4. The content was organized and easy to follow.	✓				
5. Was the material presented clearly and understandable?	✓				
6. Did you find it easy to navigate through the program?	✓				
7. The course objectives were met.	✓				
8. The time allotted for the course was sufficient.	✓				
9. Would you enrol in refresh course in the same topic? Yes/No (Tick your answer)	✓				
10. Additional trainings would you like to have in the future? Yes/No (Tick your answer)	✓				
11. Do you have any suggestions that would help us improve the quality of our course?	No suggestions.				



PRINCIPAL

Velalar College of Engineering and Technology
(Autonomous)

ERODE - 638 012.

Thank you for your feedback

VELALAR COLLEGE OF ENGINEERING AND TECHNOLOGY

Department of Civil Engineering

Value Added Course – Student Feedback Form

Date: 06/12/21

Register No: 18CE008

Student Name: Jeevarandham . N

Title of the course: Civil Engineering drawing and bar bending scheduling

	Strongly Agree	Agree	Neutral	Disagree	Strongly Disagree
1. The objective of the course were clearly defined.	✓				
2. Participation and interaction was encouraged.	✓				
3. The topics covered were relevant to course.	✓				
4. The content was organized and easy to follow.	✓				
5. Was the material presented clearly and understandable?	✓				
6. Did you find it easy to navigate through the program?	✓				
7. The course objectives were met.	✓				
8. The time allotted for the course was sufficient.	✓				
9. Would you enrol in refresh course in the same topic? Yes/No (Tick your answer)	✓				
10. Additional trainings would you like to have in the future? Yes/No (Tick your answer)	✓				
11. Do you have any suggestions that would help us improve the quality of our course?	No,				



(Handwritten Signature)

PRINCIPAL

Velalar College of Engineering and Technology
(Autonomous)

ERODE - 638 012.

Thank you for your feedback

VELALAR COLLEGE OF ENGINEERING AND TECHNOLOGY

Department of Civil Engineering

Value Added Course – Student Feedback Form

Date: 06-12-2021

Register No: 18 CEL003

Student Name: MohanShyam.T

Title of the course: Civil Engineering drawing and bar bending scheduling

	Strongly Agree	Agree	Neutral	Disagree	Strongly Disagree
1. The objective of the course were clearly defined.	✓				
2. Participation and interaction was encouraged.	✓				
3. The topics covered were relevant to course.	✓				
4. The content was organized and easy to follow.	✓				
5. Was the material presented clearly and understandable?	✓				
6. Did you find it easy to navigate through the program?	✓				
7. The course objectives were met.	✓				
8. The time allotted for the course was sufficient	✓				
9. Would you enrol in refresh course in the same topic? Yes/No (Tick your answer)					
10. Additional trainings would you like to have in the future? Yes/No (Tick your answer)					
11. Do you have any suggestions that would help us improve the quality of our course? No					



Thank you for your feedback

PRINCIPAL
Velalar College of Engineering and Technology
(Autonomous)
ERODE - 638 012.

VELALAR COLLEGE OF ENGINEERING AND TECHNOLOGY (AUTONOMOUS)

(Approved by AICTE New Delhi and Affiliated to Anna University, Chennai)
(Accredited by NAAC with 'A' Grade)
Thindal, Erode - 638012



DEPARTMENT OF CIVIL ENGINEERING

CERTIFICATE

This is to certify that Ms.JEEVITHA R (18CER009) of final year has actively participated in Value Added Course (36 hours) on "CIVIL ENGINEERING DRAWING AND BAR BENDING SCHEDULING" organised by the Department of Civil Engineering from 18th November to 09th December 2021.

Dr.E.RAVI
HOD/CIVIL



Prof.P.JAYACHANDAR
DEAN

PRINCIPAL

Velalar College of Engineering and Technology
(Autonomous)
ERODE - 638 012.

Dr.M.JAYARAMAN
PRINCIPAL

VELALAR COLLEGE OF ENGINEERING AND TECHNOLOGY (AUTONOMOUS)

(Approved by AICTE New Delhi and Affiliated to Anna University, Chennai)
(Accredited by NAAC with 'A' Grade)

Thindal, Erode - 638012

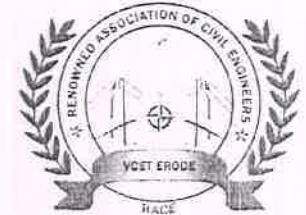

DEPARTMENT OF CIVIL ENGINEERING

CERTIFICATE

This is to certify that Ms.DHARANI V.N (18CER002) of final year has actively participated in Value Added Course (36 hours) on "CIVIL ENGINEERING DRAWING AND BAR BENDING SCHEDULING" organised by the Department of Civil Engineering from 18th November to 09th December 2021.

Dr.E.RAVI
HOD/CIVIL



Prof.P.JAYACHANDAR
DEAN

PRINCIPAL
Velalar College of Engineering and Technology
(Autonomous)
ERODE - 638 012.

Dr.M.JAYARAMAN
PRINCIPAL

VELALAR COLLEGE OF ENGINEERING AND TECHNOLOGY (AUTONOMOUS)

(Approved by AICTE New Delhi and Affiliated to Anna University, Chennai)
(Accredited by NAAC with 'A' Grade)

Thindal, Erode - 638012



DEPARTMENT OF CIVIL ENGINEERING

CERTIFICATE

This is to certify that Mr.NITHEESKUMAR R (18CER015) of final year has actively participated in Value Added Course (36 hours) on "CIVIL ENGINEERING DRAWING AND BAR BENDING SCHEDULING" organised by the Department of Civil Engineering from 18th November to 09th December 2021.

Dr.E.RAVI
HOD/CIVIL



Prof.P.JAYACHANDAR PRINCIPAL
Velalar College of Engineering and Technology
(Autonomous)
ERODE - 638 012.

Dr.M.JAYARAMAN
PRINCIPAL

VELALAR COLLEGE OF ENGINEERING AND TECHNOLOGY (AUTONOMOUS)

(Approved by AICTE New Delhi and Affiliated to Anna University, Chennai)
(Accredited by NAAC with 'A' Grade)
Thindal, Erode - 638012



DEPARTMENT OF CIVIL ENGINEERING CERTIFICATE

This is to certify that Mr.SIJIN S (18CER019) of final year has actively participated in Value Added Course (36 hours) on "CIVIL ENGINEERING DRAWING AND BAR BENDING SCHEDULING" organised by the Department of Civil Engineering from 18th November to 09th December 2021.

Dr.E.RAVI
HOD/CIVIL



Prof.P.JAYACHANDAR
DEAN
Velalar College of Engineering and Technology
(Autonomous)
ERODE - 638 012.

Dr.M.JAYARAMAN
PRINCIPAL

VELALAR COLLEGE OF ENGINEERING AND TECHNOLOGY (AUTONOMOUS)

(Approved by AICTE New Delhi and Affiliated to Anna University, Chennai)
(Accredited by NAAC with 'A' Grade)
Thindal, Erode - 638012



DEPARTMENT OF CIVIL ENGINEERING CERTIFICATE

This is to certify that Ms.SIVARANJANI D (18CER020) of final year has actively participated in Value Added Course (36 hours) on "CIVIL ENGINEERING DRAWING AND BAR BENDING SCHEDULING" organised by the Department of Civil Engineering from 18th November to 09th December 2021:

Dr.E.RAVI
HOD/CIVIL



Prof.P.JAYACHANDARA
DEAN
Velalar College of Engineering and Technology
(Autonomous)

Dr.M.JAYARAMAN
PRINCIPAL

ERODE - 638 012.

VELALAR COLLEGE OF ENGINEERING AND TECHNOLOGY (AUTONOMOUS)

(Approved by AICTE New Delhi and Affiliated to Anna University, Chennai)
(Accredited by NAAC with 'A' Grade)

Thindal, Erode - 638012



DEPARTMENT OF CIVIL ENGINEERING

CERTIFICATE

This is to certify that Mr.KABILAN PL (18CER010) of final year has actively participated in Value Added Course (36 hours) on "CIVIL ENGINEERING DRAWING AND BAR BENDING SCHEDULING" organised by the Department of Civil Engineering from 18th November to 09th December 2021.

Dr.E.RAVI
HOD/CIVIL



Prof.P.JAYACHANDAR
DEAN
PRINCIPAL
Velalar College of Engineering and Technology
(Autonomous)
ERODE - 638 012.

Dr.M.JAYARAMAN
PRINCIPAL

VELALAR COLLEGE OF ENGINEERING AND TECHNOLOGY (AUTONOMOUS)

(Approved by AICTE New Delhi and Affiliated to Anna University, Chennai)
(Accredited by NAAC with 'A' Grade)
Thindal, Erode - 638012



DEPARTMENT OF CIVIL ENGINEERING

CERTIFICATE

This is to certify that Ms.MAYURII P (18CER012) of final year has actively participated in Value Added Course (36 hours) on "CIVIL ENGINEERING DRAWING AND BAR BENDING SCHEDULING" organised by the Department of Civil Engineering from 18th November to 09th December 2021.

Handwritten signature of Dr. E. Ravi

Dr.E.RAVI
HOD/CIVIL



Handwritten signature of Prof. P. Jayachandar

Prof.P.JAYACHANDAR
DEAN
Velalar College of Engineering and Technology
(Autonomous)
ERODE - 638 012.

Handwritten signature of Dr. M. Jayaraman

Dr.M.JAYARAMAN
PRINCIPAL



VELALAR COLLEGE OF ENGINEERING AND TECHNOLOGY, ERODE

DEPARTMENT OF CIVIL ENGINEERING

07.12.2021

Value Added Course on
'Civil Engineering drawing and bar bending scheduling'

A Report

The department of Civil Engineering of Velalar College of Engineering and Technology has organized a thirty-six hours Value Added Course on "Civil Engineering drawing and bar bending scheduling" during 18.11.2021 to 06.12.2021. Thirty-four students from Civil Final year has been actively participated the course. The course has been conducted at Civil Engineering CADD Lab on daily basis. The resource persons for the courses are Mr.S.Suresh and Mr.S.C.Sarathkumar, Assistant Professor of Civil Engineering Department, VCET.

The following portions are covered during the course

Basics of bar bending schedule

- Importance of spacing and diameter of reinforcement
- Identification & importance of main & secondary bar
- Identification of different types of stirrups and cranks/ shear bars

RCC detailing using software

Generation of detailed drawings for given specification and preparation of bar bending schedule using AutoCAD

- Continuous one-way slab (with three equal spans)
- Simply supported two-way slab
- Doubly reinforced continuous beam with two equal spans
- Dog-legged staircase
- RCC column with square isolated footing

Practical session on word processing, spread sheet and presentation has been held on Civil Engineering CADD lab. On the end the MCQ test for evaluation was held on 06.12.2021. All the Thirty-four students were participated and cleared the course successfully. Feedback about the course has been collected from the participants which reflects the usefulness of the course. Course completion certificate has been issues to all the successful participants.

P.C. Suresh
7/12/21
Course Coordinator

HOD/Civil
21/12/21



HOD/Civil
PRINCIPAL
Velalar College of Engineering and Technology
(Autonomous)
ERODE - 638 012.